

Varenummer: 40600734432420

Beskrivelse: Tandhjulsgeær C704F-344,3-P63B5

Mål

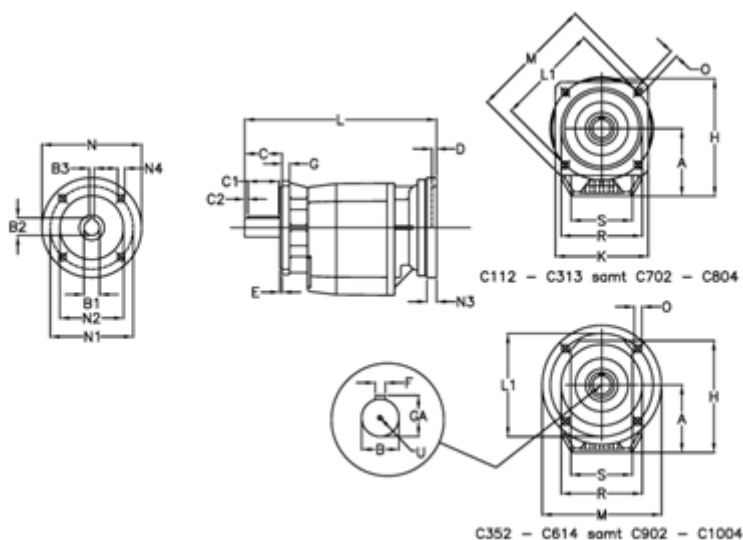

A = 208.0	D = 4.0	L1 = 300	R = 262
B = 60	E = 5	M = 350	S = 250
B1 = 11	F = 18	N = 140	U = M20x42
B2 = 12.8	G = 17	N1 = 115	
B3 = 4	GA = 64.0	N2 = 95	
C = 120	H = 358.0	N3 = 0	
C1 = 90	K = 300	N4 = M8x19	
C2 = 15	L = 504.5	O = 18.0	